

423-940	LB2-230-K002	1ヶ月予定表
---------	--------------	--------

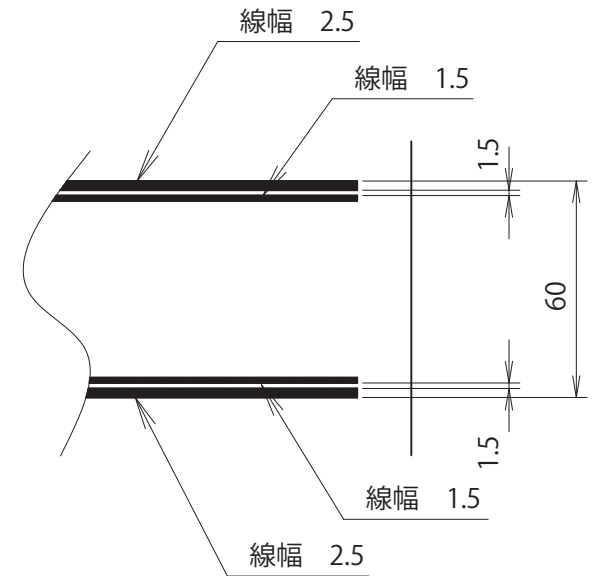
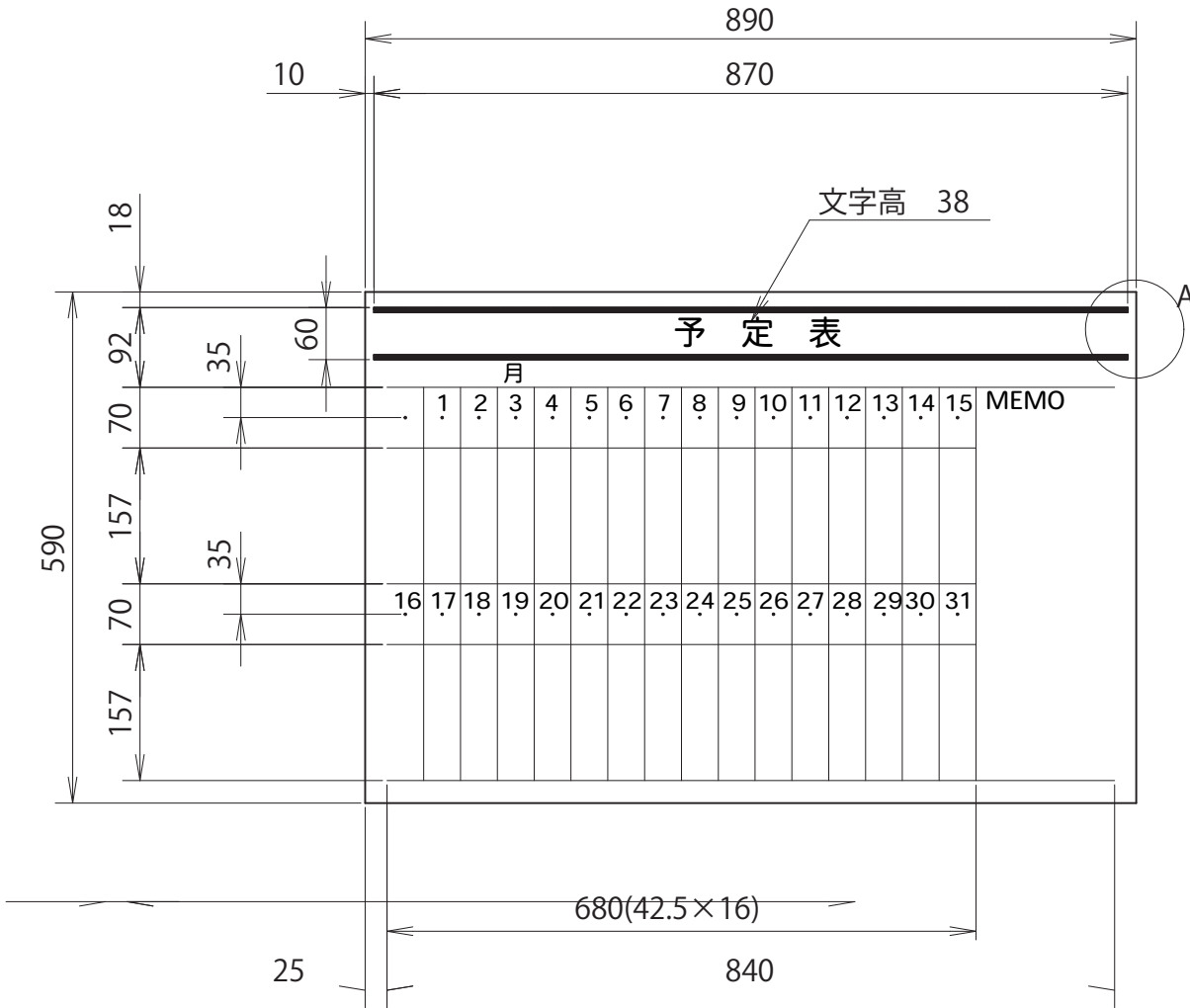

A部罫線パターン (1:2)